

- 75.0 MHz IF SAW Filter / 27.12 MHz Bandwidth
- Revision 0: 05. Aug. 2008

Electrical Characteristics

MAXIMUM RATING				
PARAMETERS DESCRIPTION	UNIT	MINIMUM	TYPICAL	MAXIMUM
Operation Temperature Range	°C	-20	-	70
Storage Temperature Range	°C	-40	-	85
Maximum DC Voltage	V	-	-	10
Maximum Input Power	dBm	-	-	10
Source Impedance (single ended) ⁽¹⁾	Ω	-	50	-
Load Impedance (single ended) ⁽¹⁾	Ω	-	50	-
Package type & size	D1			
Length x Width	mm ²	-	20.0 x 9.8	-
Height	mm	-	-	1.8

ELECTRICAL SPECIFICATION				
PARAMETERS DESCRIPTION	UNIT	MINIMUM	TYPICAL	MAXIMUM
Center Frequency (Fo)	MHz	-	75.0	-
Insertion Loss at Fo	dB	-	26.50	28.00
Group Delay Variation (Fo±12.48MHz)	ns	-	21	-
Absolute Delay	us	-	1.65	-
Temperature Coefficient	ppm/°C	-	-72	-
Passband Ripple (Fo±12.48MHz)	dB	-	0.40	0.95
Bandwidth at -1dB	MHz	-	27.12	-
Bandwidth at -3dB	MHz	27.50	27.64	-
Bandwidth at -30dB	MHz	-	29.42	29.52
Bandwidth at -50dB	MHz	-	29.85	-
Ultimate Rejection	dB	-	52	-

Notes : (1) With Matching Network (Ref. Testing Environment Circuit as shown below).
Those impedances could be modified with different impedance values and/or structures, if necessary.

Package Dimensions

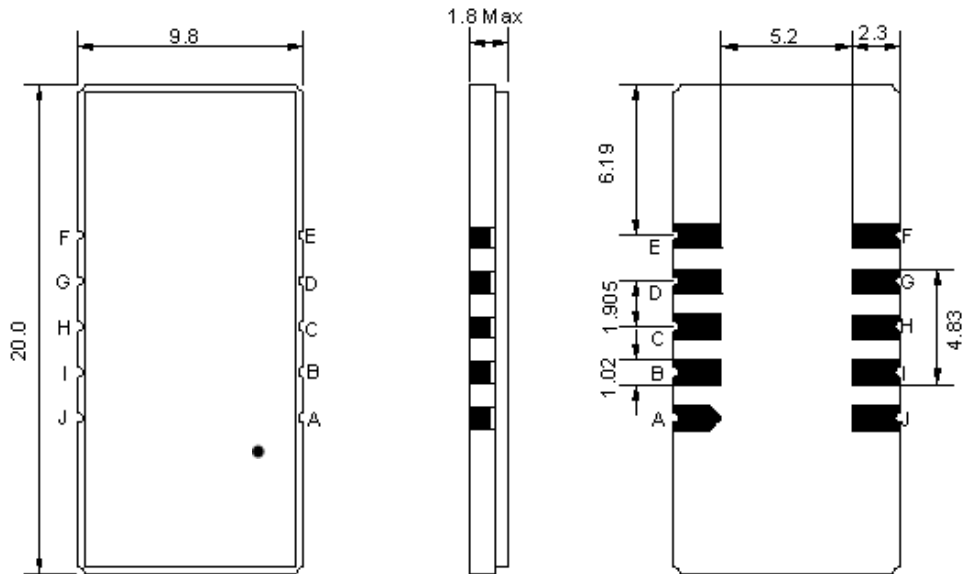

- ① TRANSKO: Brand
- ② TA07527A: Model Name
- ③ X : Date Code (Year)
- ④ Y : Date Code (Month)
- ⑤ Z : Date Code (Date)
- : Index Dot

Pin Description	
A, B, C, D, F, G, H, I	Ground
J	Input
E	Output

Testing Environment

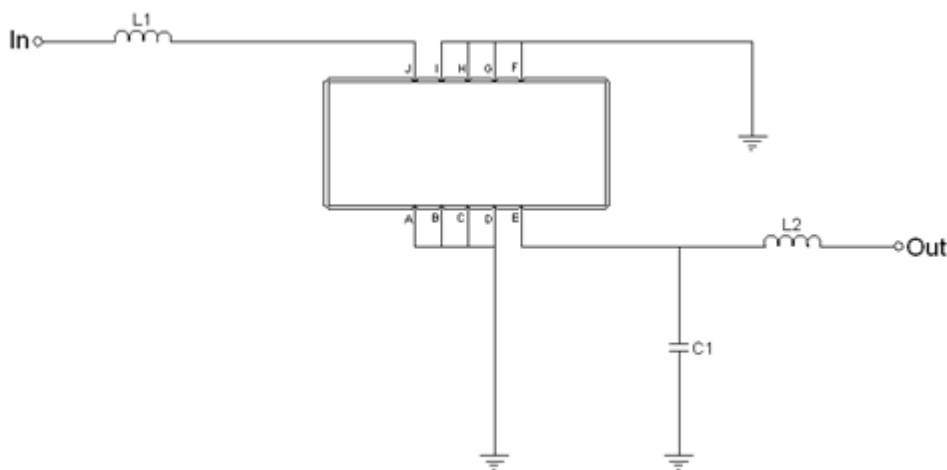

Test Fixture & Values	
Input	L1=150 nH
Output	C1=12 pF, L2=150 nH
Source/Load Impedance	50 Ω

Frequency Characteristics

Frequency Response

Bandwidth at -1.0 dB

Bandwidth at -3.0 dB

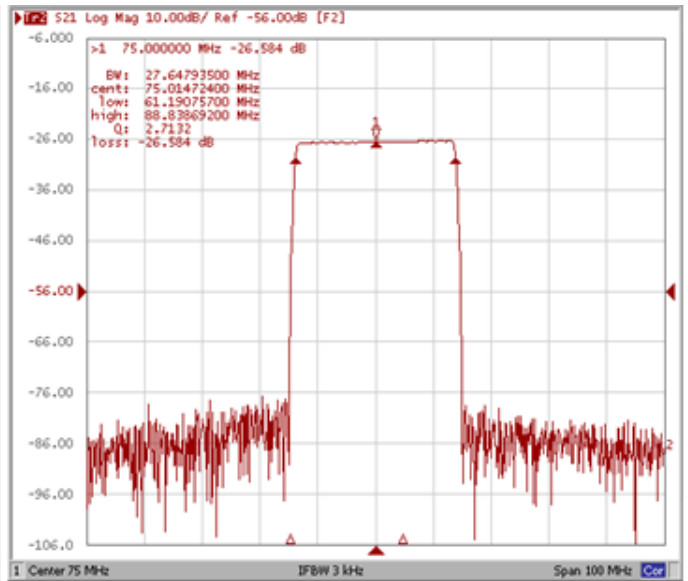
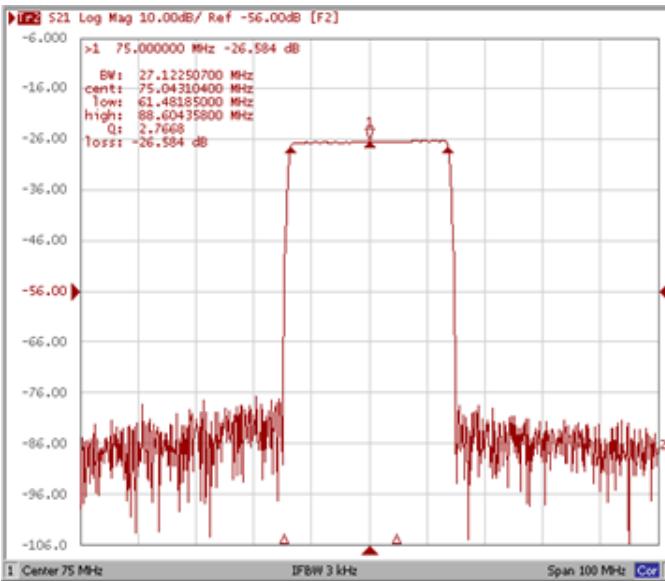

Bandwidth at -30.0 dB

Bandwidth at -50.0 dB

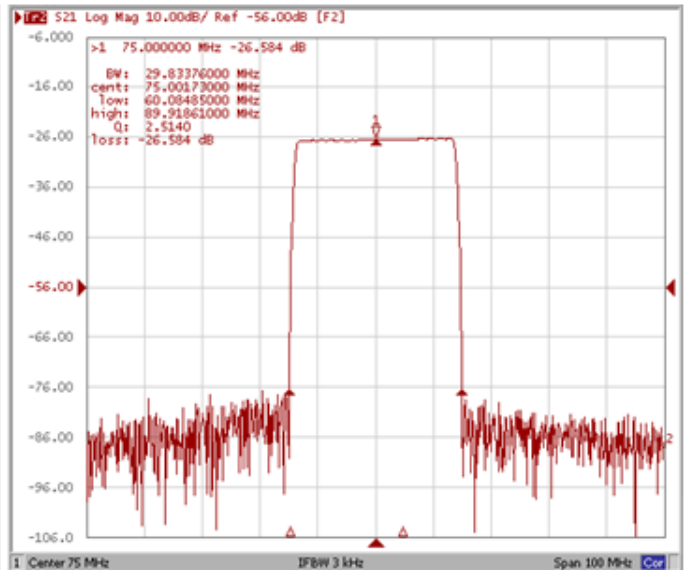
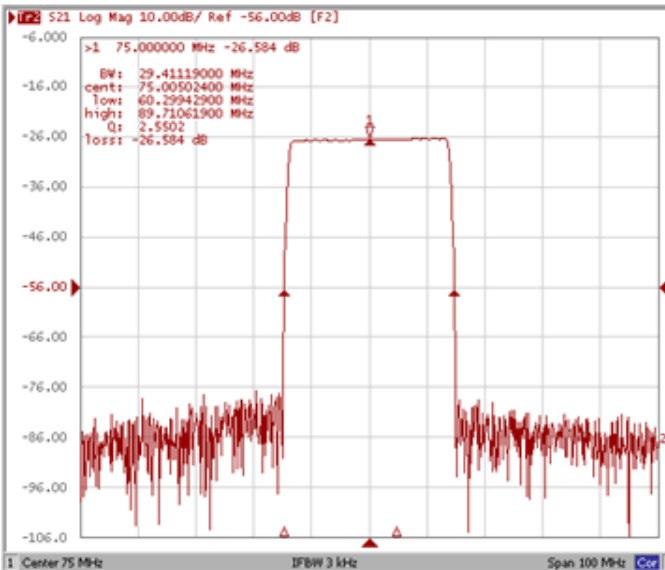

Frequency Response

Ripple Variation Fo±12.48MHz

Group Delay Variation Fo±12.48MHz

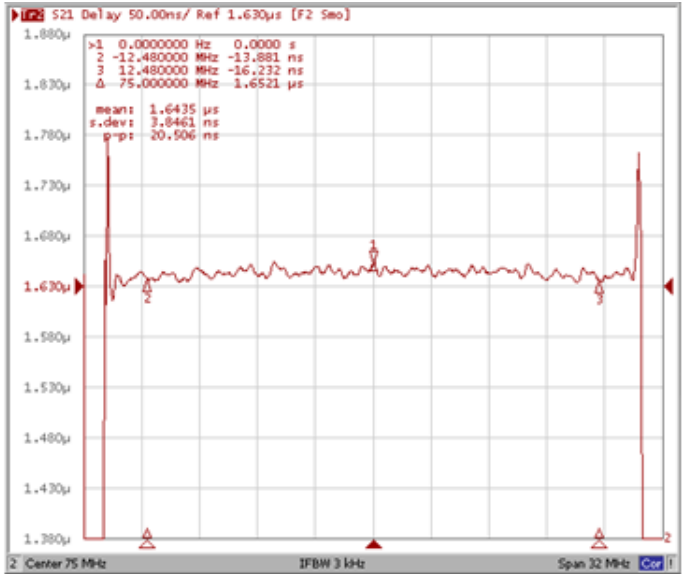
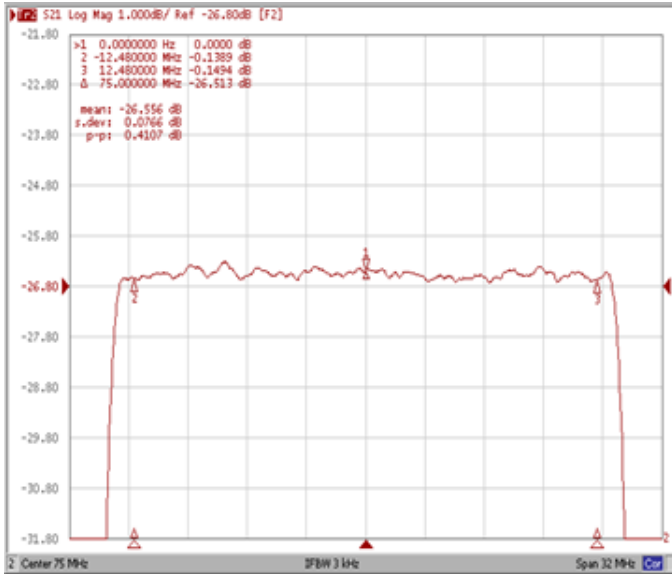

Smith Chart

VSWR

