

- 75.0 MHz IF SAW Filter / 26.16 MHz Bandwidth
- Revision 0: 11. Mar. 2009

Electrical Characteristics

MAXIMUM RATING				
PARAMETERS DESCRIPTION	UNIT	MINIMUM	TYPICAL	MAXIMUM
Operation Temperature Range	°C	-20	-	70
Storage Temperature Range	°C	-40	-	85
Maximum DC Voltage	V	-	-	10
Maximum Input Power	dBm	-	-	10
Source Impedance (single ended) ⁽¹⁾	Ω	-	50	-
Load Impedance (single ended) ⁽¹⁾	Ω	-	50	-
Package type & size	D1			
Length x Width	mm ²	-	20.0 x 9.8	-
Height	mm	-	-	1.8

ELECTRICAL SPECIFICATION				
PARAMETERS DESCRIPTION	UNIT	MINIMUM	TYPICAL	MAXIMUM
Center Frequency (Fo)	MHz	-	75.0	-
Insertion Loss at Fo	dB	-	27.5	29.0
Group Delay Variation (Fo±12.48MHz)	nsec	-	25	50
Absolute Delay at Fo	usec	-	1.98	-
Passband Ripple Variation(Fo±12.48MHz)	dB	-	0.42	0.90
Bandwidth at -1dB	MHz	25.9	26.16	-
Bandwidth at -10dB	MHz	-	27.16	-
Bandwidth at -20dB	MHz	-	27.63	-
Bandwidth at -40dB	MHz	-	28.12	28.30
Ultimate Rejection	dB	50	52	-
Temperature Coefficient	ppm/°C	-	-72	-

Notes : (1) With Matching Network (Ref. Testing Environment Circuit as shown below).
Those impedances could be modified with different impedance values and/or structures, if necessary.

Package Dimensions

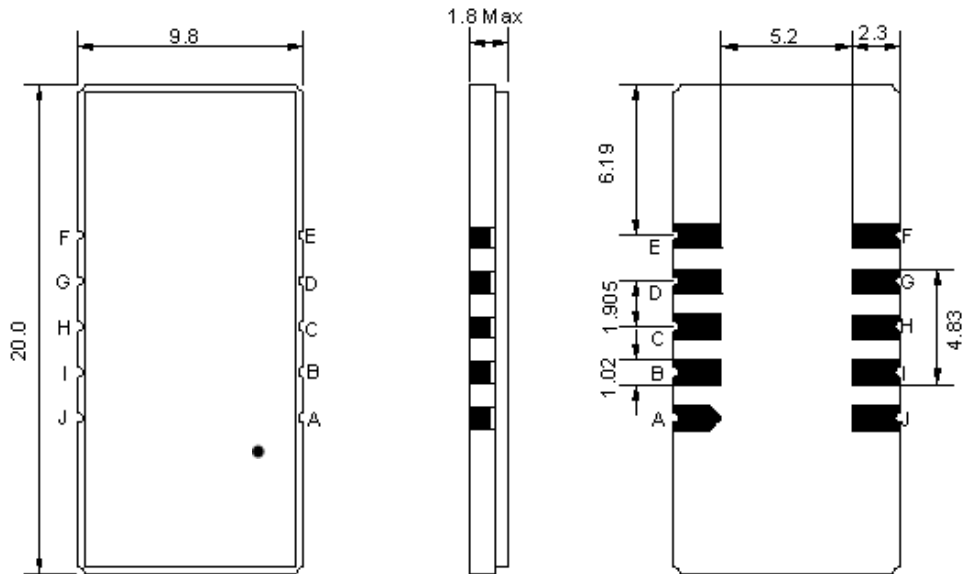

- ① TRANSKO: Brand
- ② TA07526B: Model Name
- ③ X : Date Code (Year)
- ④ Y : Date Code (Month)
- ⑤ Z : Date Code (Date)
- : Index Dot

Pin Description	
A, B, C, D, F, G, H, I	Ground
J	Input
E	Output

Testing Environment

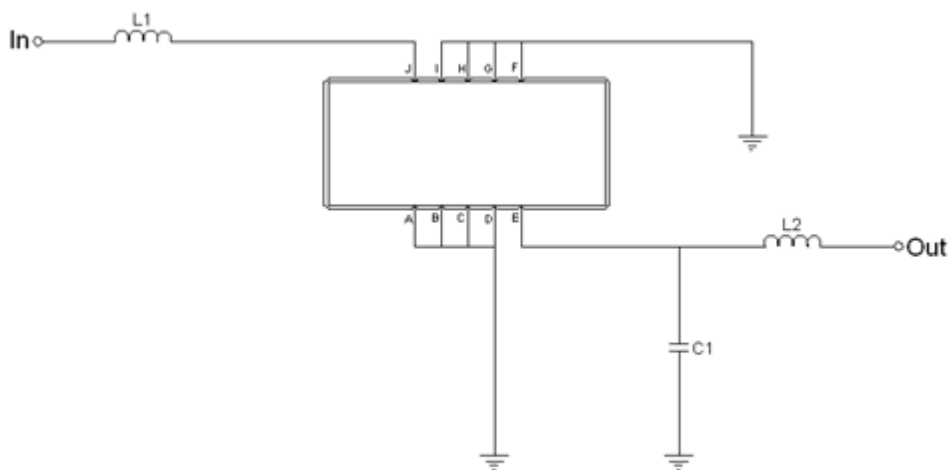

Test Fixture & Values	
Input	L1 = 120 nH
Output	L2 = 120 nH, C1=3.3pF
Source/Load Impedance	50 Ω

Frequency Characteristics

Frequency Response

Bandwidth at -1.0 dB

Bandwidth at -10.0 dB

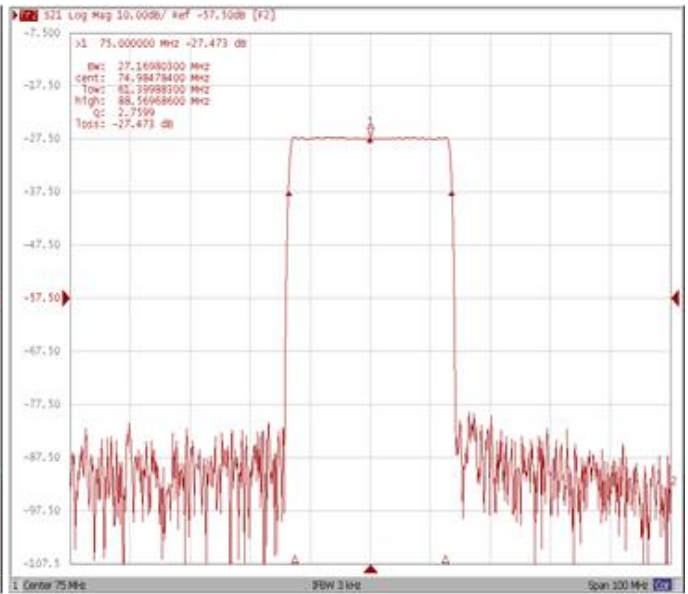
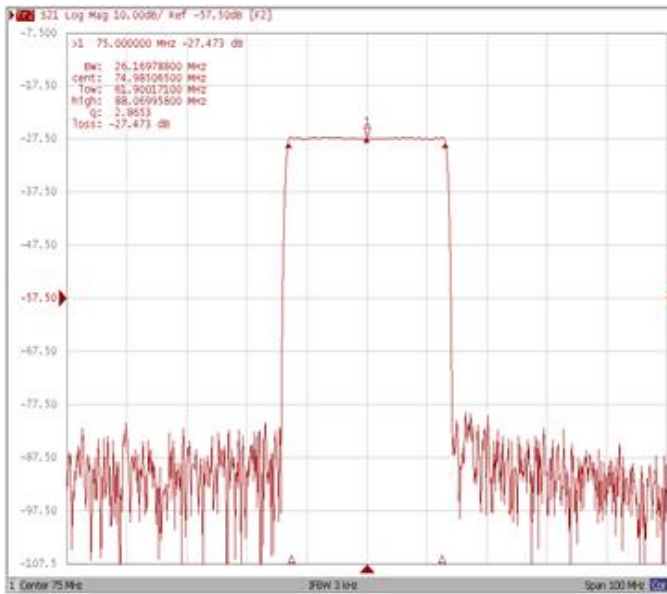

Bandwidth at -20.0 dB

Bandwidth at -40.0 dB

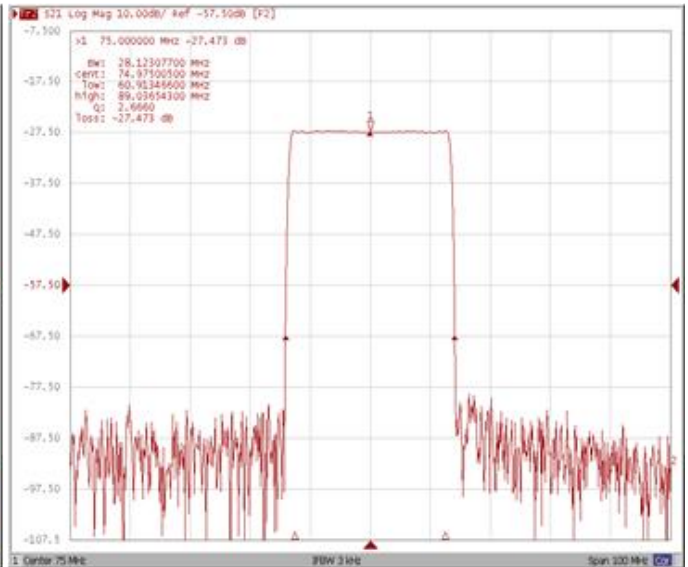
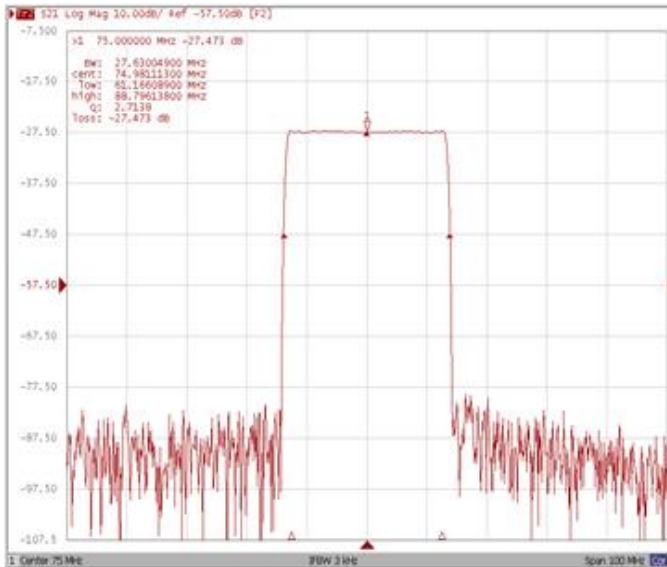

Frequency Response

Ripple Variation Fo±12.48MHz

Group Delay Variation Fo±12.48MHz

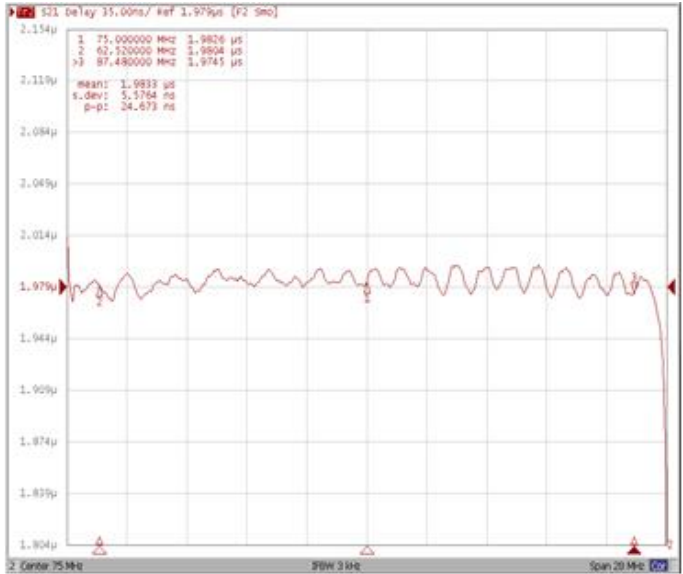
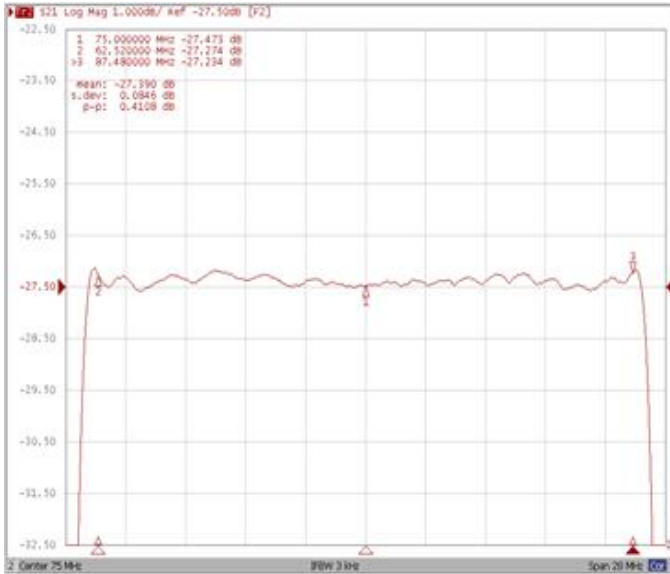

Smith Chart

VSWR

