

- CDMA450 Rx Balanced SAW Duplexer For 455.0 MHz / 465.0 MHz
- Revision 0: January 2011

Electrical Characteristics

MAXIMUM RATING				
PARAMETERS DESCRIPTION	UNIT	MINIMUM	TYPICAL	MAXIMUM
Operating Temperature Range	°C	-30	-	+85
Storage Temperature Range	°C	-40	-	+85
Maximum DC Voltage	V	-	0	-
Input Power Level	dBm	29dBm> 50000 Hours, CW tone(Ta= +55°C)		
Antenna & Tx Impedance (single ended)	Ω	-	50	-
Rx Impedance (balanced) ⁽¹⁾	Ω	-	100	-
Package type & size	K5			
Length x Width	mm ²	-	5.0 x 5.0	-
Height	mm	-	1.8	-

ELECTRICAL SPECIFICATION					
PARAMETERS	CONDITION [MHZ]	UNIT	MINIMUM	TYPICAL	MAXIMUM
Tx → Ant		Specifications			
Insertion Loss	452.5 ~ 457.5	dB	-	2.0	3.2
Return Loss	452.5 ~ 457.5	dB	8	11	-
Absolute Attenuation	462.5 ~ 467.5	dB	45	55	-
	1574.0	dB	20	28	-
	480.0 ~ 1200.0	dB	25	30	-
	1200.0 ~ 2100.0	dB	10	17	-
Ant → Rx		Specifications			
Insertion Loss	462.5 ~ 467.5	dB	-	3.0	3.8
Amplitude Imbalance	462.5 ~ 467.5	dB	-1.0	-0.5/0.35	1.0
Phase Imbalance	462.5 ~ 467.5	deg	-10	6.0/8.0	10
Return Loss	462.5 ~ 467.5	dB	8	10	-
Absolute Attenuation	452.5 ~ 457.5	dB	45	52	-
	477.0 ~ 480.0	dB	30	35	-
	480.0 ~ 1200.0	dB	30	35	-
	1200.0 ~ 2100.0	dB	18	25	-
Tx → Rx		Specifications			
Isolation	452.5 ~ 457.5	dB	52	63	-
	462.5 ~ 467.5	dB	52	65	-

Notes : (1) No Matching Network .

Package Dimensions

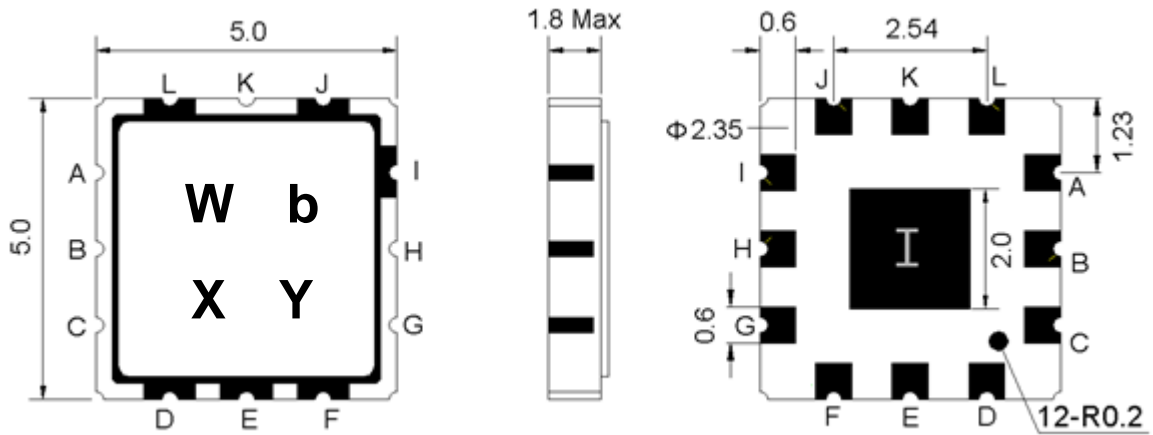

Marking Descriptions	
W	CDMA450 Application
b	Series Number
X	Date Code (Year)
Y	Date Code (Month)

Pin Description	
A, C, D, E, F, I, J, L	Ground
K	Antenna
B	Tx
G, H	Rx Balanced

Testing Environment

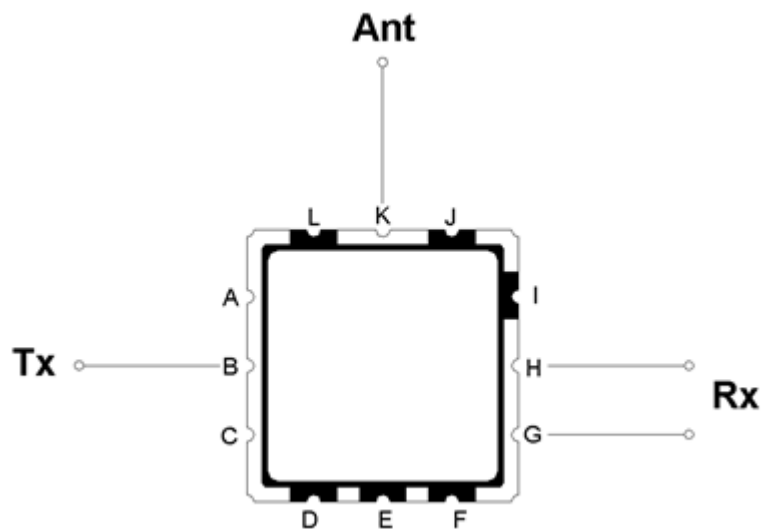

Frequency Characteristics

Tx to Ant

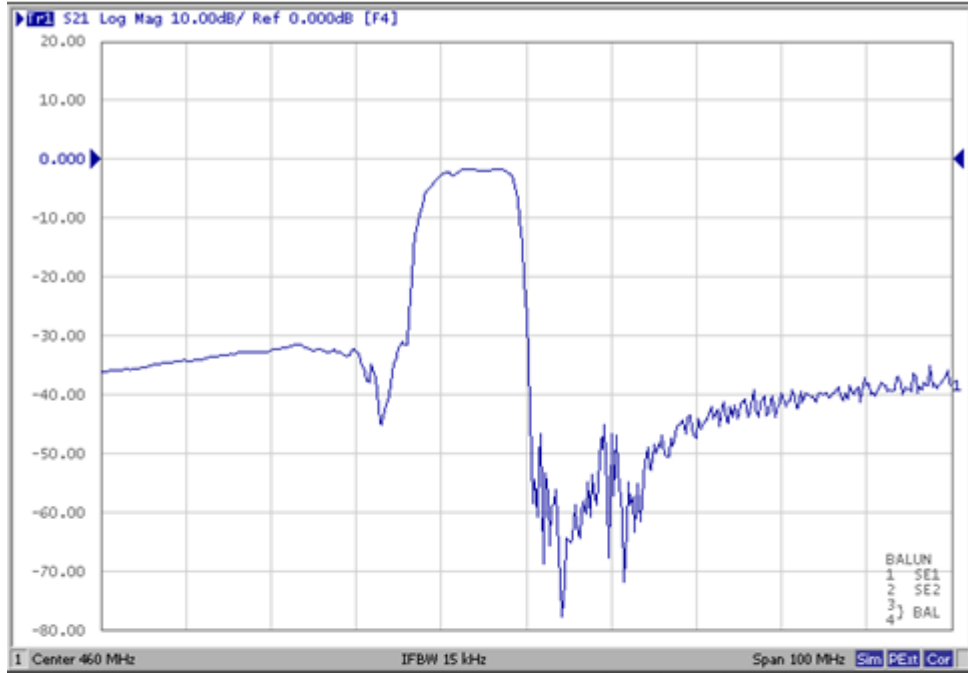

Ant to Rx

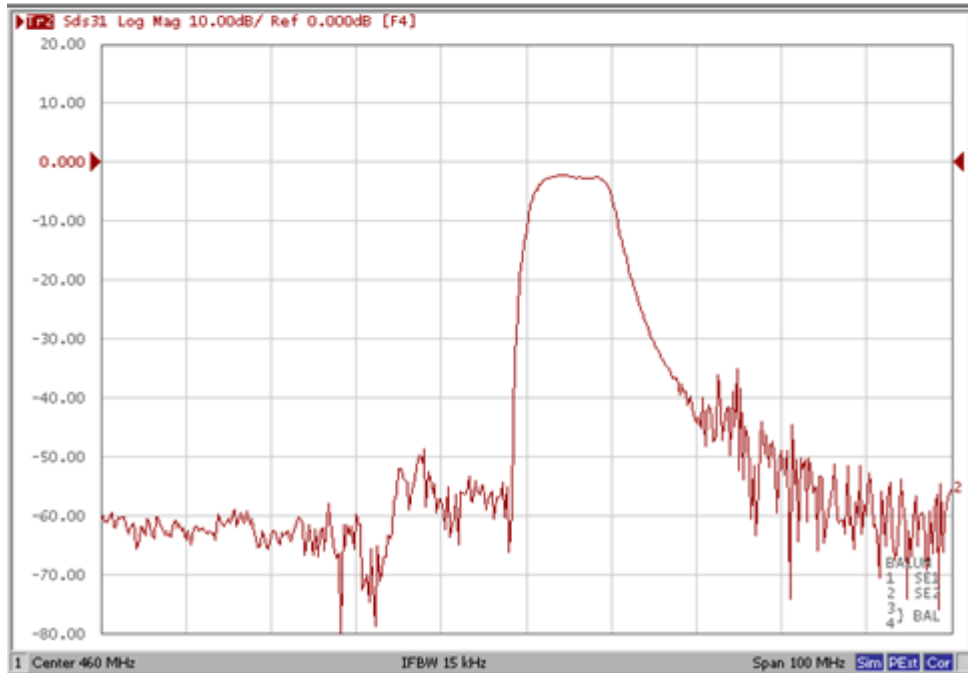

Isolation

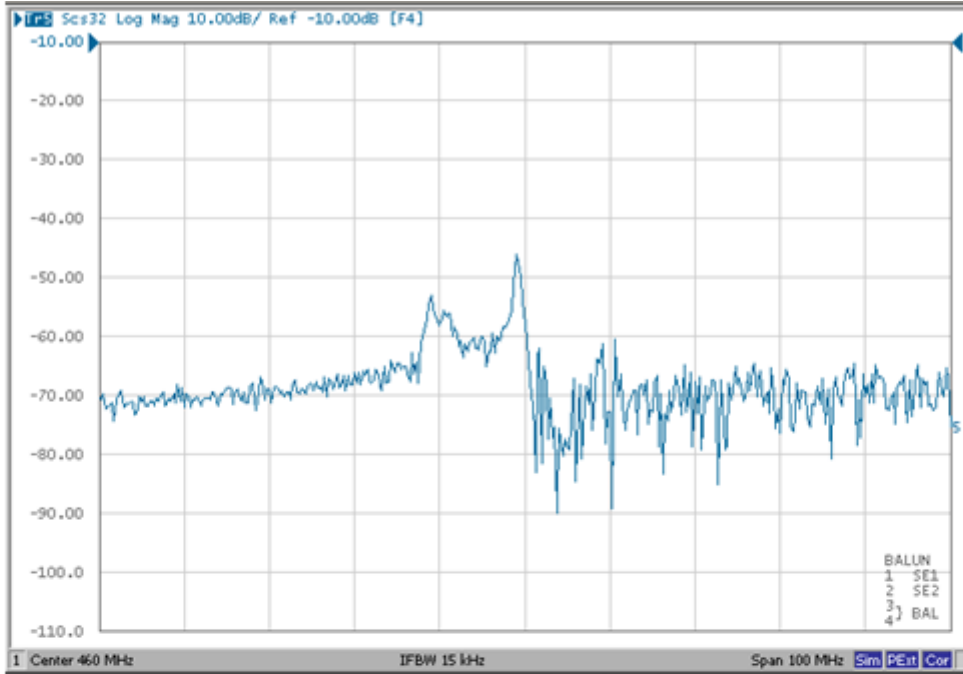

Tx Port

Smith Chart

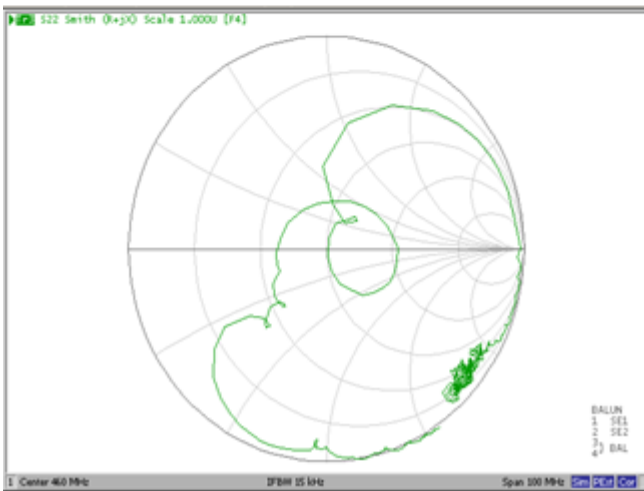

Return Loss

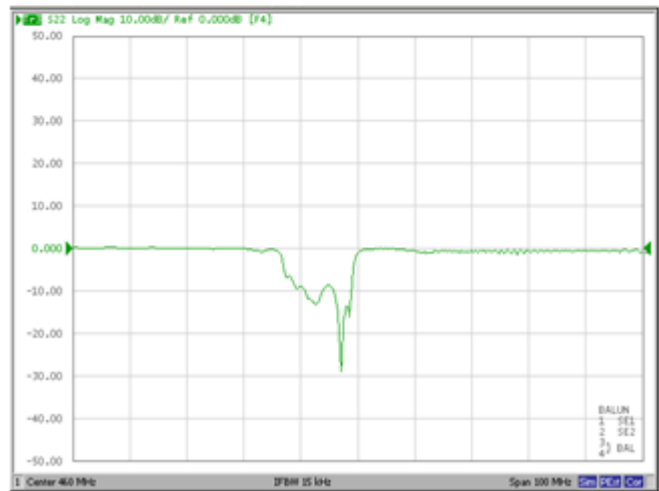

Rx Port

Smith Chart

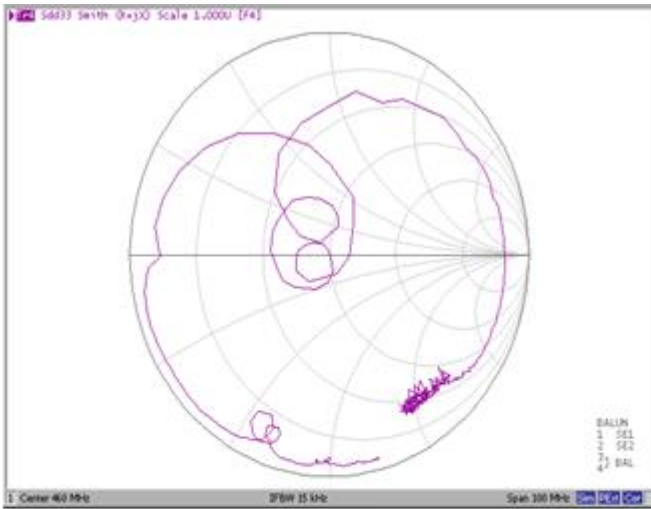

Return Loss

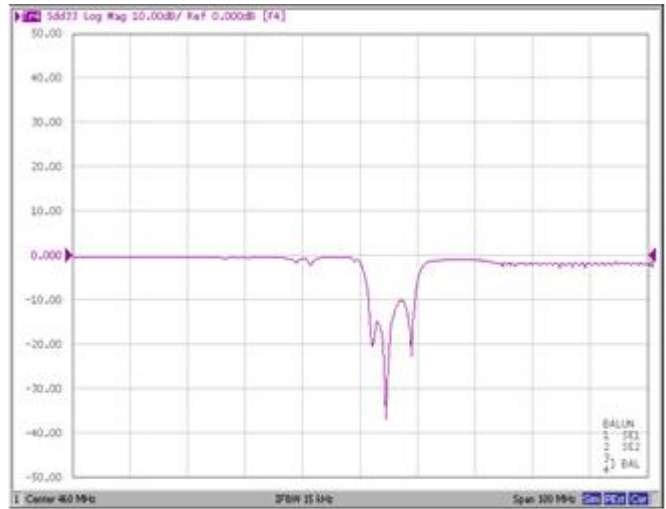

Ant Port

Smith Chart

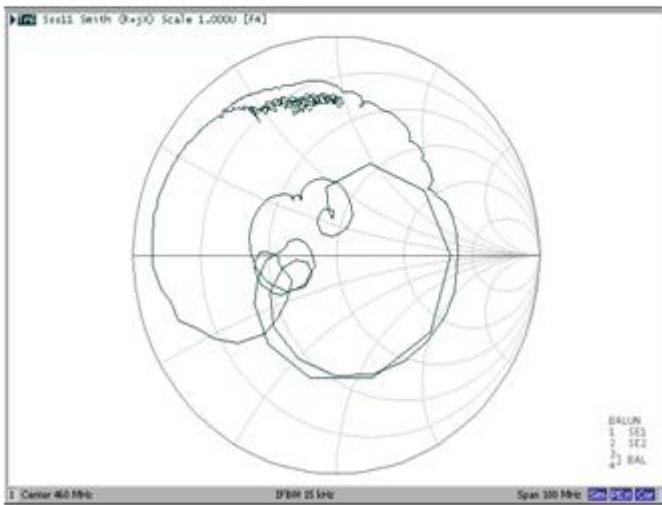

Return Loss



Wide Span

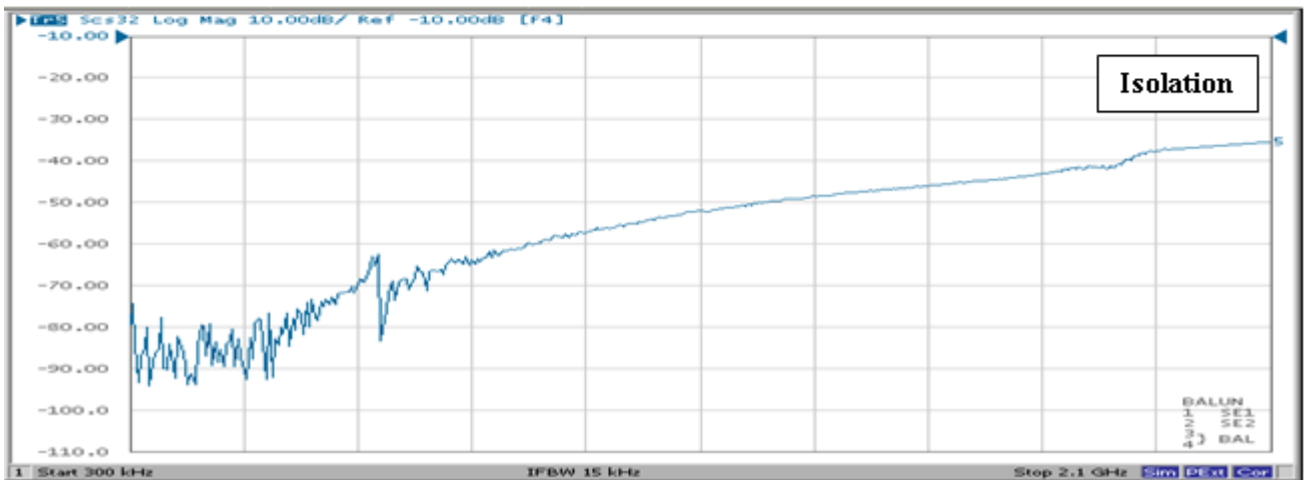
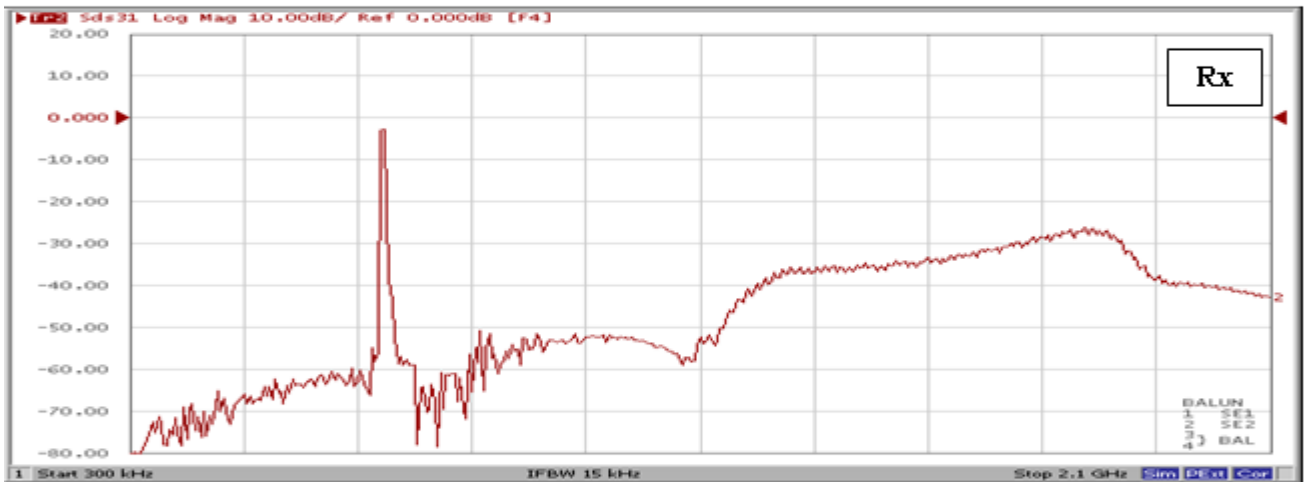

Amplitude Imbalance



Phase Imbalance

